



佳恒冷氣工程有限公司

Kai Hang Air-Cond. Eng Co. Ltd

香港新界葵涌葵豐街41-45號安福工業大廈16樓H室
Block H, 16/F, On Fook Industrial Building,
41-45 Kwai Fung Crescent, Kwai Chung, N.T., Hong Kong
Fax: (852) 3171 7810 Phone: (852) 3171 7781, 3172 1073



CABLE TRUNKING

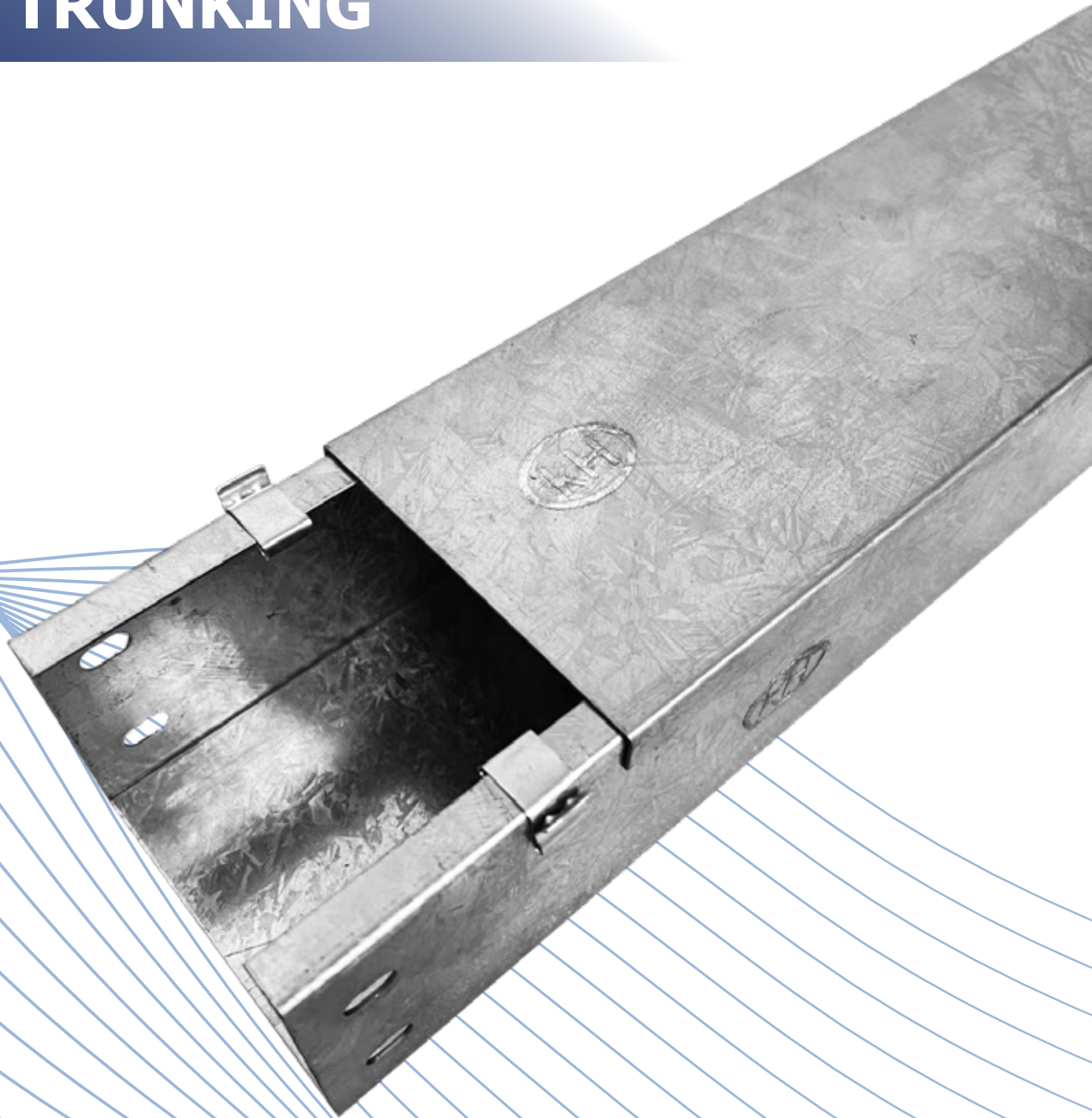

Product images
產品圖片



Cable trunking, basket, tray, ladder product codes
線槽, 線籃, 托盤, 梯架 產品代號

PRODUCT TYPE DIMENSION FITTINGS THICKNESS OTHER
產品類 尺寸 配件/ 曲編號 厚度 其他

e.g **DQ** **4 X3** **.1** **H12** **R**

TRUNKING 線槽

DQ
Centre Caption
肚臍蓋
DJ
Clip Fix
彈夾蓋
LS
Screw Fix
螺絲蓋

4X3

4" inches wide 闊

X

3" inches tall 高

.1
90°Bend
Front opening 正曲
.2
90°Bend
Internal opening
內曲
.3
Tee Bend
三叉曲
.4
90°Bend
External opening
外曲
.5
90°Cross Fitting
十字曲
.6 A / B / C
Reducer fitting
刁士正/左/右
.11 A / B / C
135°Bend
Front / Internal /
External
135°正/內/ 外曲

H9
0.9mm
H10
1.0mm
H11
1.12mm
H12
1.2mm
H14
1.4mm
H15
1.5mm
H16
1.6mm
H18
1.8mm
H20
2.0mm

M
Double / Multi
compartment
孖格
(Trunking only)
(只限線槽)
R
Hot Dip Galvanized
熱浸鋅
P
Paint
(Epoxy powder)
(噴粉)
S
304 Stainless Steel
304 不銹鋼
X
316 Stainless steel
316 不銹鋼

Cable Trunking 電線槽

STANDARDS

BS 4678 Part 1 Class 2 & 3 Corrosion Protection, BS1449, BSEN 50085-1,2-1, IEC 61084-1, 2-1, BSEN 10139, EN 10143, BSEN 10149

規格標準

BS 4678 Part 1 Class 2 & 3 抗蝕保護, BS1449, BSEN 50085-1,2-1, IEC 61084-1, 2-1, BSEN 10139, EN 10143, BSEN 10149

TRUNKING COVER TYPE

Centre Caption (DQ)
Screw Fix (LS)
Clip Fix (DJ)

槽蓋款式

肚臍蓋(DQ)
螺絲蓋(LS)
彈夾蓋(DJ)

MATERIAL

Galvanised Steel Sheet
Mild Steel
Stainless Steel Sheet SS304 (S), SS316 (X)

原料

鍍鋅鋼板
鋼板
不銹鋼板SS304 (S), SS316 (X)

LENGTH

Standard length of 2.44m,
Other lengths available on request

長度

標準2.44m,
其他長度可按照客需要

THICKNESS

Comply to BS 4678
Other thicknesses can be made
(0.9mm -2.0mm)

厚度

符合BS 4678要求
其他厚度由0.9mm -2.0mm 可按要求生產

FINISHES

Hot Dip Galvanized to BS729, ISO1460, 1461 (H)
Coloured Epoxy Powder Coating / High Grade Outdoor Powder (P)

表面處理

熱浸鋅符合標準BS729, ISO1460, 1461 (H)
顏色聚脂油粉 / 高級戶外粉 (P)

SEPARATE COMPARTMENTS

2 compartment (D), or multi compartment (T)
as requested

槽內間格

可按照客人的要求製成二倉式(D), 多倉式(T)

Fittings and accessories meet the same standard and specifications as trunkings
線槽配件的規格及標準完全遵照及配合電線槽而製成

Cable trunking 電線槽

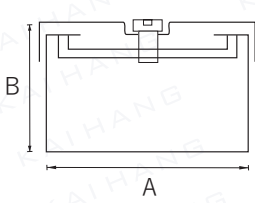
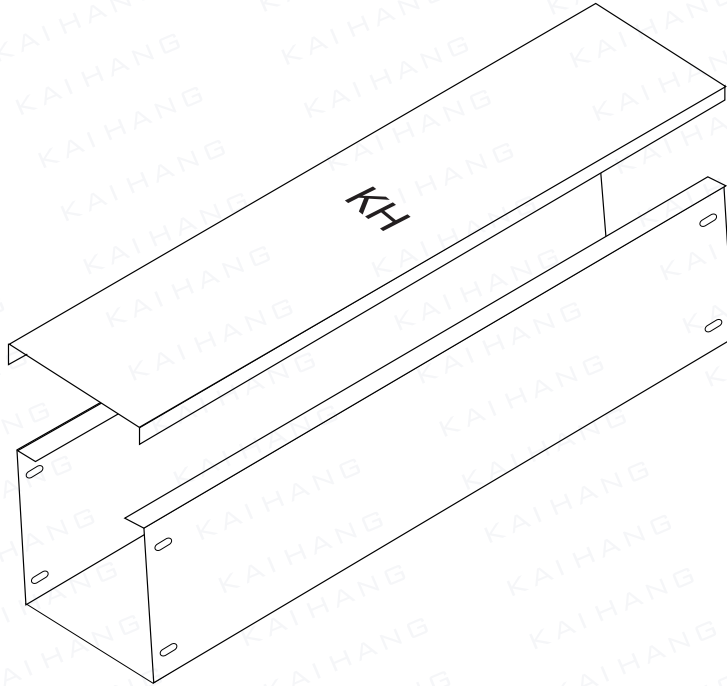

Centre Caption 肚臍蓋型

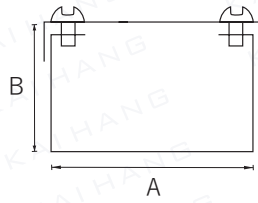

Screw Fix 螺絲蓋型

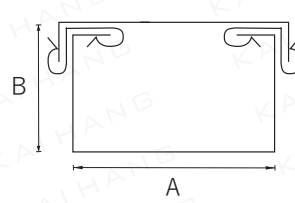

Clip Fix 彈夾蓋型

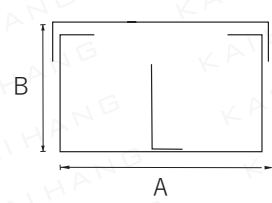

Multi-Compartment 分格式

Cable trunking size 電線槽尺寸 (mm)	Dimension 尺寸 (mm)		Model Number 型號		
	A	B	Centre Caption (DQ) 肚臍蓋型	Screw Fix (LS) 螺絲蓋型	Clip Fix (DJ) 彈夾蓋型
50 x 50	50	50	DQ2X2H10	LS2X2H10	DJ2X2H10
75 x 50	75	50	DQ3X2H12	LS3X2H12	DJ3X2H12
75 x 75	75	75	DQ3X3H12	LS3X3H12	DJ3X3H12
100 x 75	100	75	DQ4X3H12	LS4X3H12	DJ4X3H12
100 x 100	100	100	DQ4X4H14	LS4X4H14	DJ4X4H14
150 x 100	150	100	DQ6X4H14	LS6X4H14	DJ6X4H14
150 x 150	150	150	DQ6X6H16	LS6X6H16	DJ6X6H16
200 x 150	200	150	DQ8X6H16	LS8X6H16	DJ8X6H16
200 x 200	200	200	DQ8X8H16	LS8X8H16	DJ8X8H16

Other sizes can be custom made
其他尺寸可按客戶要求生產

Cable trunking - Fittings and accessories 電線槽曲及配件

90° Mitre bend 90° 斜角槽曲

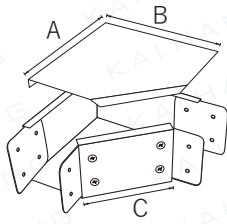

Front opening 正面蓋型

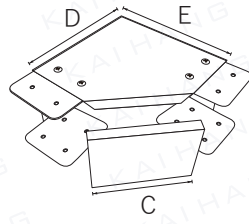

Internal opening 內開蓋型

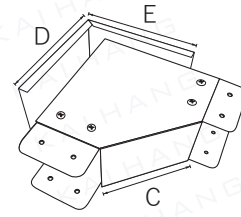

External opening 外開蓋型

Suitable for trunking size 適用線槽尺寸 (mm)	Dimension 尺寸 (mm)					Model: Centre Caption 肚臍蓋型 (DQ), Screw Fix 螺絲蓋型 (LS), Clip fix 彈夾蓋型 (DJ)		
	A	B	C	D	E	Front opening 正面蓋型	Internal Opening 內開蓋型	External opening 外開蓋型
50 x 50	125	125	106	125	125	DQ/LS/DJ 2X2.1AH10	DQ/LS/DJ 2X2.2AH10	DQ/LS/DJ 2X2.4AH10
75 x 50	150	150	106	125	125	DQ/LS/DJ 3X2.1AH12	DQ/LS/DJ 3X2.2AH12	DQ/LS/DJ 3X2.4AH12
75 x 75	150	150	106	150	150	DQ/LS/DJ 3X3.1AH12	DQ/LS/DJ 3X3.2AH12	DQ/LS/DJ 3X3.4AH12
100 x 75	175	175	106	150	150	DQ/LS/DJ 4X3.1AH12	DQ/LS/DJ 4X3.2AH12	DQ/LS/DJ 4X3.4AH12
100 x 100	175	175	106	175	175	DQ/LS/DJ 4X4.1AH14	DQ/LS/DJ 4X4.2AH14	DQ/LS/DJ 4X4.4AH14
150 x 100	225	225	106	175	175	DQ/LS/DJ 6X4.1AH14	DQ/LS/DJ 6X4.2AH14	DQ/LS/DJ 6X4.4AH14
150 x 150	225	225	106	225	225	DQ/LS/DJ 6X6.1AH16	DQ/LS/DJ 6X6.2AH16	DQ/LS/DJ 6X6.4AH16
200 x 150	275	275	106	225	225	DQ/LS/DJ 8X6.1AH16	DQ/LS/DJ 8X6.2AH16	DQ/LS/DJ 8X6.4AH16
200 x 200	275	275	106	275	275	DQ/LS/DJ 8X8.1AH16	DQ/LS/DJ 8X8.2AH16	DQ/LS/DJ 8X8.4AH16

90° Sharp bend 90° 死角槽曲

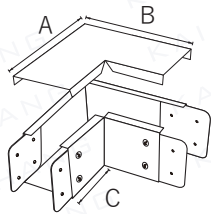

Front opening 正面蓋型

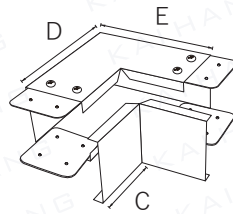

Internal opening 內開蓋型

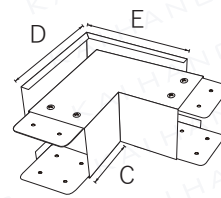

External opening 外開蓋型

Suitable for trunking size 適用線槽尺寸 (mm)	Dimension 尺寸 (mm)					Model: Centre Caption 肚臍蓋型 (DQ), Screw Fix 螺絲蓋型 (LS), Clip fix 彈夾蓋型 (DJ)		
	A	B	C	D	E	Front opening 正面蓋型	Internal Opening 內開蓋型	External opening 外開蓋型
50 x 50	125	125	75	125	125	DQ/LS/DJ 2X2.1BH10	DQ/LS/DJ 2X2.2BH10	DQ/LS/DJ 2X2.4BH10
75 x 50	150	150	75	125	125	DQ/LS/DJ 3X2.1BH12	DQ/LS/DJ 3X2.2BH12	DQ/LS/DJ 3X2.4BH12
75 x 75	150	150	75	150	150	DQ/LS/DJ 3X3.1BH12	DQ/LS/DJ 3X3.2BH12	DQ/LS/DJ 3X3.4BH12
100 x 75	175	175	75	150	150	DQ/LS/DJ 4X3.1BH12	DQ/LS/DJ 4X3.2BH12	DQ/LS/DJ 4X3.4BH12
100 x 100	175	175	75	175	175	DQ/LS/DJ 4X4.1BH14	DQ/LS/DJ 4X4.2BH14	DQ/LS/DJ 4X4.4BH14
150 x 100	225	225	75	175	175	DQ/LS/DJ 6X4.1BH14	DQ/LS/DJ 6X4.2BH14	DQ/LS/DJ 6X4.4BH14
150 x 150	225	225	75	225	225	DQ/LS/DJ 6X6.1BH16	DQ/LS/DJ 6X6.2BH16	DQ/LS/DJ 6X6.4BH16
200 x 150	275	275	75	225	225	DQ/LS/DJ 8X6.1BH16	DQ/LS/DJ 8X6.2BH16	DQ/LS/DJ 8X6.4BH16
200 x 200	275	275	75	275	275	DQ/LS/DJ 8X8.1BH16	DQ/LS/DJ 8X8.2BH16	DQ/LS/DJ 8X8.4BH16

Cable trunking - Fittings and accessories 電線槽曲及配件

Mitre tee 斜角三叉

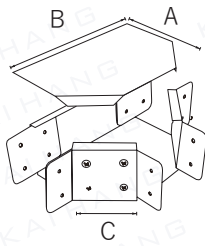

Front opening
正面蓋型

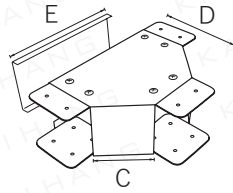

Top opening-Type 1
頂開蓋型-款式1

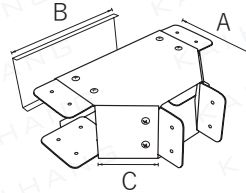

Top opening-Type 2
頂開蓋型-款式2

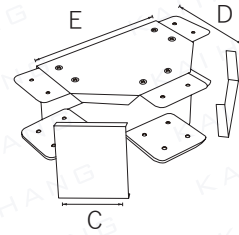

Internal opening
內開蓋型

Suitable for trunking size 適用線槽尺寸 (mm)	Dimension 尺寸 (mm)					Model: Centre Caption 肚臍蓋型 (DQ), Screw Fix 螺絲蓋型 (LS), Clip fix 彈夾蓋型 (DJ)			
	A	B	C	D	E	Front opening 正面蓋型	Top opening - Type 1 頂開蓋型-款式1	Top opening - Type 2 頂開蓋型-款式2	Internal Opening 內開蓋型
50 x 50	100	150	70	100	150	DQ/LS/DJ 2X2.3AH10	DQ/LS/DJ 2X2.3A1H10	DQ/LS/DJ 2X2.3A2H10	DQ/LS/DJ 2X2.3A3H10
75 x 50	125	175	70	100	150	DQ/LS/DJ 3X2.3AH12	DQ/LS/DJ 3X2.3A1H12	DQ/LS/DJ 3X2.3A2H12	DQ/LS/DJ 3X2.3A3H12
75 x 75	125	175	70	125	175	DQ/LS/DJ 3X3.3AH12	DQ/LS/DJ 3X3.3A1H12	DQ/LS/DJ 3X3.3A2H12	DQ/LS/DJ 3X3.3A3H12
100 x 75	150	200	70	125	175	DQ/LS/DJ 4X3.3AH12	DQ/LS/DJ 4X3.3A1H12	DQ/LS/DJ 4X3.3A2H12	DQ/LS/DJ 4X3.3A3H12
100 x 100	150	200	70	150	200	DQ/LS/DJ 4X4.3AH14	DQ/LS/DJ 4X4.3A1H14	DQ/LS/DJ 4X4.3A2H14	DQ/LS/DJ 4X4.3A3H14
150 x 100	225	300	106	175	250	DQ/LS/DJ 6X4.3AH14	DQ/LS/DJ 6X4.3A1H14	DQ/LS/DJ 6X4.3A2H14	DQ/LS/DJ 6X4.3A3H14
150 x 150	225	300	106	225	300	DQ/LS/DJ 6X6.3AH16	DQ/LS/DJ 6X6.3A1H16	DQ/LS/DJ 6X6.3A2H16	DQ/LS/DJ 6X6.3A3H16
200 x 150	275	350	106	225	300	DQ/LS/DJ 8X6.3AH16	DQ/LS/DJ 8X6.3A1H16	DQ/LS/DJ 8X6.3A2H16	DQ/LS/DJ 8X6.3A3H16
200 x 200	275	350	106	275	350	DQ/LS/DJ 8X8.3AH16	DQ/LS/DJ 8X8.3A1H16	DQ/LS/DJ 8X8.3A2H16	DQ/LS/DJ 8X8.3A3H16

Sharp tee 死角三叉

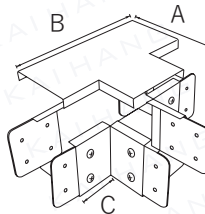

Front opening
正面蓋型

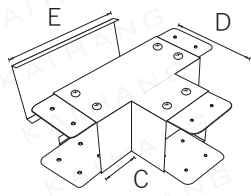

Top opening-Type 1
頂開蓋型-款式1

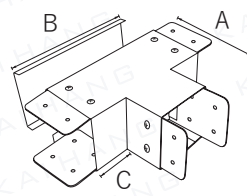

Top opening-Type 2
頂開蓋型-款式2

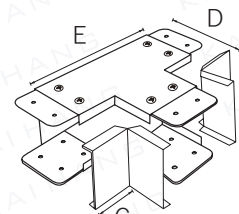

Internal opening
內開蓋型

Suitable for trunking size 適用線槽尺寸 (mm)	Dimension 尺寸 (mm)					Model: Centre Caption 肚臍蓋型 (DQ), Screw Fix 螺絲蓋型 (LS), Clip fix 彈夾蓋型 (DJ)			
	A	B	C	D	E	Front opening 正面蓋型	Top opening - Type 1 頂開蓋型-款式1	Top opening - Type 2 頂開蓋型-款式2	Internal Opening 內開蓋型
50 x 50	100	150	50	100	150	DQ/LS/DJ 2X2.3BH10	DQ/LS/DJ 2X2.3B1H10	DQ/LS/DJ 2X2.3B2H10	DQ/LS/DJ 2X2.3B3H10
75 x 50	125	175	50	100	150	DQ/LS/DJ 3X2.3BH12	DQ/LS/DJ 3X2.3B1H12	DQ/LS/DJ 3X2.3B2H12	DQ/LS/DJ 3X2.3B3H12
75 x 75	125	175	50	125	175	DQ/LS/DJ 3X3.3BH12	DQ/LS/DJ 3X3.3B1H12	DQ/LS/DJ 3X3.3B2H12	DQ/LS/DJ 3X3.3B3H12
100 x 75	150	200	50	125	175	DQ/LS/DJ 4X3.3BH12	DQ/LS/DJ 4X3.3B1H12	DQ/LS/DJ 4X3.3B2H12	DQ/LS/DJ 4X3.3B3H12
100 x 100	150	200	50	150	200	DQ/LS/DJ 4X4.3BH14	DQ/LS/DJ 4X4.3B1H14	DQ/LS/DJ 4X4.3B2H14	DQ/LS/DJ 4X4.3B3H14
150 x 100	225	300	75	175	250	DQ/LS/DJ 6X4.3BH14	DQ/LS/DJ 6X4.3B1H14	DQ/LS/DJ 6X4.3B2H14	DQ/LS/DJ 6X4.3B3H14
150 x 150	225	300	75	225	300	DQ/LS/DJ 6X6.3BH16	DQ/LS/DJ 6X6.3B1H16	DQ/LS/DJ 6X6.3B2H16	DQ/LS/DJ 6X6.3B3H16
200 x 150	275	350	75	225	300	DQ/LS/DJ 8X6.3BH16	DQ/LS/DJ 8X6.3B1H16	DQ/LS/DJ 8X6.3B2H16	DQ/LS/DJ 8X6.3B3H16
200 x 200	275	350	75	275	350	DQ/LS/DJ 8X8.3BH16	DQ/LS/DJ 8X8.3B1H16	DQ/LS/DJ 8X8.3B2H16	DQ/LS/DJ 8X8.3B3H16

Cable trunking - Fittings and accessories 電線槽曲及配件

135° Bend 135° 斜角槽曲

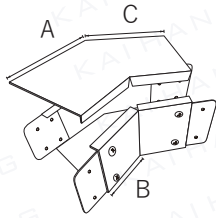

Front opening 正面蓋型

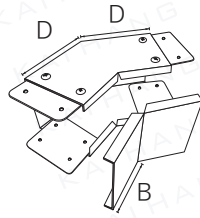

Internal opening 內開蓋型

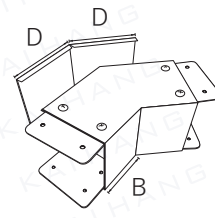

External opening 外開蓋型

Suitable for trunking size 適用線槽尺寸 (mm)	Dimension 尺寸 (mm)				Model: Centre Caption 肚臍蓋型 (DQ), Screw Fix 螺絲蓋型 (LS), Clip fix 彈夾蓋型 (DJ)		
	A	B	C	D	Front opening 正面蓋型	Internal Opening 內開蓋型	External opening 外開蓋型
50 x 50	95	75	95	95	DQ/LS/DJ 2X2.11AH10	DQ/LS/DJ 2X2.11BH10	DQ/LS/DJ 2X2.11CH10
75 x 50	105	75	105	95	DQ/LS/DJ 3X2.11AH12	DQ/LS/DJ 3X2.11BH12	DQ/LS/DJ 3X2.11CH12
75 x 75	105	75	105	105	DQ/LS/DJ 3X3.11AH12	DQ/LS/DJ 3X3.11BH12	DQ/LS/DJ 3X3.11CH12
100 x 75	116	75	116	105	DQ/LS/DJ 4X3.11AH12	DQ/LS/DJ 4X3.11BH12	DQ/LS/DJ 4X3.11CH12
100 x 100	116	75	116	116	DQ/LS/DJ 4X4.11AH14	DQ/LS/DJ 4X4.11BH14	DQ/LS/DJ 4X4.11CH14
150 x 100	137	75	137	116	DQ/LS/DJ 6X4.11AH14	DQ/LS/DJ 6X4.11BH14	DQ/LS/DJ 6X4.11CH14
150 x 150	137	75	137	137	DQ/LS/DJ 6X6.11AH16	DQ/LS/DJ 6X6.11BH16	DQ/LS/DJ 6X6.11CH16
200 x 150	157	75	157	137	DQ/LS/DJ 8X6.11AH16	DQ/LS/DJ 8X6.11BH16	DQ/LS/DJ 8X6.11CH16
200 x 200	157	75	157	157	DQ/LS/DJ 8X8.11AH16	DQ/LS/DJ 8X8.11BH16	DQ/LS/DJ 8X8.11CH16

90° Mitre Cross 90° 十字槽曲

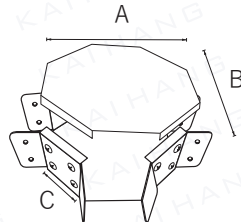

Front opening 正面蓋型

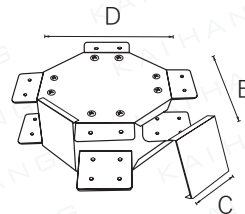

Internal opening 內開蓋型

Suitable for trunking size 適用線槽尺寸 (mm)	Dimension 尺寸 (mm)					Model: Centre Caption 肚臍蓋型 (DQ), Screw Fix 螺絲蓋型 (LS), Clip fix 彈夾蓋型 (DJ)	
	A	B	C	D	E	Flat Bend 正曲型	Internal Bend 內曲型
50 x 50	150	150	70	150	150	DQ/LS/DJ 2X2.5AH10	DQ/LS/DJ 2X2.5BH10
75 x 50	175	175	70	150	150	DQ/LS/DJ 3X2.5AH12	DQ/LS/DJ 3X2.5BH12
75 x 75	175	175	70	175	175	DQ/LS/DJ 3X3.5AH12	DQ/LS/DJ 3X3.5BH12
100 x 75	200	200	70	175	175	DQ/LS/DJ 4X3.5AH12	DQ/LS/DJ 4X3.5BH12
100 x 100	200	200	70	200	200	DQ/LS/DJ 4X4.5AH14	DQ/LS/DJ 4X4.5BH14
150 x 100	300	300	106	250	250	DQ/LS/DJ 6X4.5AH14	DQ/LS/DJ 6X4.5BH14
150 x 150	300	300	106	300	300	DQ/LS/DJ 6X6.5AH16	DQ/LS/DJ 6X6.5BH16
200 x 150	350	350	106	300	300	DQ/LS/DJ 8X6.5AH16	DQ/LS/DJ 8X6.5BH16
200 x 200	350	350	106	350	350	DQ/LS/DJ 8X8.5AH16	DQ/LS/DJ 8X8.5BH16

Cable trunking - Fittings and accessories 電線槽曲及配件

Flared connector 槽蓋刁士

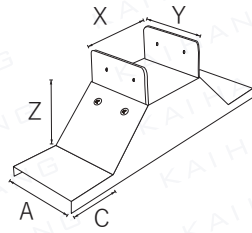

Top opening 喇叭咀

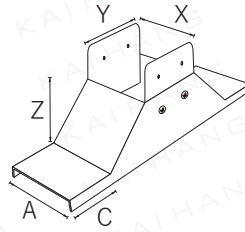

Top opening 90° 槽蓋刁士

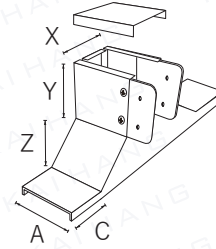

Side opening 扭向槽口短蓋

Suitable for trunking size 適用線槽尺寸 (mm)	Dimension 尺寸 (mm)					Model: Centre Caption 肚臍蓋型 (DQ), Screw Fix 螺絲蓋型 (LS), Clip fix 彈夾蓋型 (DJ)		
	A	C	X	Y	Z	Top Opening 喇叭咀	Top Opening (90°) 槽蓋刁士	Side Opening 扭向槽口短蓋
50 x 50	50	50	50	50	50	DQ/LS/DJ 2X2.5CH10	DQ/LS/DJ 2X2.5DH10	DQ/LS/DJ 2X2.5EH10
75 x 50	75	50	75	50	50	DQ/LS/DJ 3X2.5CH12	DQ/LS/DJ 3X2.5DH12	DQ/LS/DJ 3X2.5EH12
75 x 75	75	50	75	75	50	DQ/LS/DJ 3X3.5CH12	DQ/LS/DJ 3X3.5DH12	DQ/LS/DJ 3X3.5EH12
100 x 75	100	50	100	75	50	DQ/LS/DJ 4X3.5CH12	DQ/LS/DJ 4X3.5DH12	DQ/LS/DJ 4X3.5EH12
100 x 100	100	50	100	100	50	DQ/LS/DJ 4X4.5CH14	DQ/LS/DJ 4X4.5DH14	DQ/LS/DJ 4X4.5EH14
150 x 100	150	50	150	100	50	DQ/LS/DJ 6X4.5CH14	DQ/LS/DJ 6X4.5DH14	DQ/LS/DJ 6X4.5EH14
150 x 150	150	50	150	150	50	DQ/LS/DJ 6X6.5CH16	DQ/LS/DJ 6X6.5DH16	DQ/LS/DJ 6X6.5EH16
200 x 150	200	50	200	150	50	DQ/LS/DJ 8X6.5CH16	DQ/LS/DJ 8X6.5DH16	DQ/LS/DJ 8X6.5EH16
200 x 200	200	50	200	200	50	DQ/LS/DJ 8X8.5CH16	DQ/LS/DJ 8X8.5DH16	DQ/LS/DJ 8X8.5EH16

Reducer 刁士

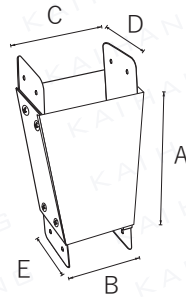

Equal 正刁士

Suitable for trunking size 適用線槽尺寸 (mm)	Dimension 尺寸 (mm)					Model: Centre Caption (DQ) Screw Fix 螺絲蓋型 (LS) Clip fix 彈夾蓋型 (DJ)
	A	B	C	D	E	
75x75-50x50	150	50	75	75	50	DQ/LS/DJ3X3.6AH12
100x50-50x50	150	50	100	50	50	DQ/LS/DJ4X2.6AH12
100x100-75x75	150	75	100	100	75	DQ/LS/DJ4X4.6AH14
150x100-100x100	200	100	150	100	100	DQ/LS/DJ6X4.6AH14
150x150-100x100	200	100	150	150	100	DQ/LS/DJ6X6.6AH16
200x200 - 150x150	200	150	200	200	150	DQ/LS/DJ8X8.6AH16

Cable trunking - Fittings and accessories 電線槽曲及配件

Reducer 刁士

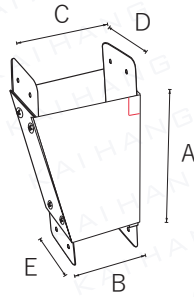

Left 左刁士

Suitable for trunking size 適用線槽尺寸 (mm)	Dimension 尺寸 (mm)					Model: Centre Caption 肚臍蓋型(DQ) Screw Fix 螺絲蓋型 (LS) Clip fix 彈夾蓋型 (DJ)
	A	B	C	D	E	
75x75-50x50	150	50	75	75	50	DQ/LS/DJ3X3.6BH12
100x50-50x50	150	50	100	50	50	DQ/LS/DJ4X2.6BH12
100x100-75x75	150	75	100	100	75	DQ/LS/DJ4X4.6BH14
150x100-100x100	200	100	150	100	100	DQ/LS/DJ6X4.6BH14
150x150-100x100	200	100	150	150	100	DQ/LS/DJ6X6.6BH16
200x200 - 150x150	200	150	200	200	150	DQ/LS/DJ8X8.6BH16

Reducer 刁士

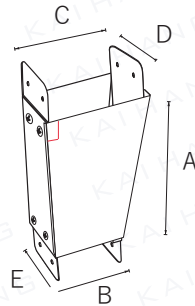

Right

Suitable for trunking size 適用線槽尺寸 (mm)	Dimension 尺寸 (mm)					Model: Centre Caption 肚臍蓋型(DQ) Screw Fix 螺絲蓋型 (LS) Clip fix 彈夾蓋型 (DJ)
	A	B	C	D	E	
75x75-50x50	150	50	75	75	50	DQ/LS/DJ3X3.6CH12
100x50-50x50	150	50	100	50	50	DQ/LS/DJ4X2.6CH12
100x100-75x75	150	75	100	100	75	DQ/LS/DJ4X4.6CH14
150x100-100x100	200	100	150	100	100	DQ/LS/DJ6X4.6CH14
150x150-100x100	200	100	150	150	100	DQ/LS/DJ6X6.6CH16
200x200 - 150x150	200	150	200	200	150	DQ/LS/DJ8X8.6CH16

Cable trunking - Fittings and accessories 電線槽曲及配件

End cap 槽尾凸

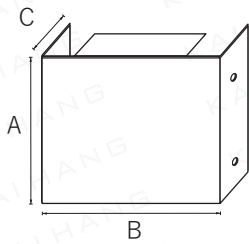

Suitable for trunking size 適用線槽尺寸 (mm)	Dimension 尺寸 (mm)			Model Number 型號
	A	B	C	
50 x 50	48	48	25	CWK2X2
75 x 50	48	73	25	CWK3X2
75 x 75	73	73	25	CWK3X3
100 x 75	73	98	25	CWK4X3
100 x 100	98	98	25	CWK4X4
150 x 100	98	148	25	CWK6X4
150 x 150	148	148	25	CWK6X6
200 x 150	148	198	25	CWK8X6
200 x 200	198	198	25	CWK8X8

Cable support 電線掛片

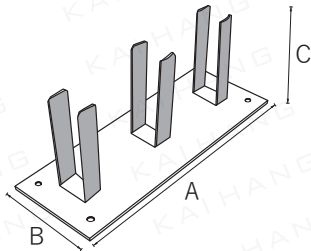

Suitable for trunking size 適用線槽尺寸 (mm)	Dimension 尺寸 (mm)			Model Number 型號
	A	B	C	
50 x 50	250	45	45	GP2X2
75 x 50	250	70	45	GP3X2
75 x 75	250	70	70	GP3X3
100 x 75	250	95	70	GP4X3
100 x 100	250	95	95	GP4X4
150 x 100	250	145	95	GP6X4
150 x 150	250	145	145	GP6X6
200 x 150	250	195	145	GP8X6
200 x 200	250	195	195	GP8X8

Trunking connector 槽駁片

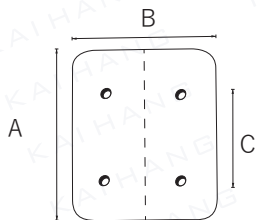

Couple connector 對裝槽駁片

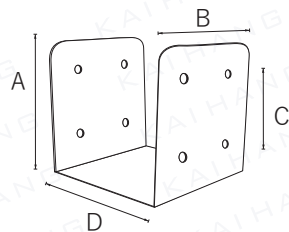

U-shaped connector U 型槽駁片

Suitable for trunking size 適用線槽尺寸 (mm)	Dimension 尺寸 (mm)				Model Number 型號	
	A	B	C	D	Couple Connector 對裝槽駁片	U-shaped Connector U 型槽駁片
50 x 50	45	70	-	48	DZC2	UXC2X2
75 x 50	45	70	-	73	DZC2	UXC3X2
75 x 75	70	70	35	73	DZC3	UXC3X3
100 x 75	70	70	35	98	DZC3	UXC4X3
100 x 100	95	70	60	98	DZC4	UXC4X4
150 x 100	95	70	60	148	DZC4	UXC6X4
150 x 150	145	70	111	148	DZC6	UXC6X6
200 x 150	145	70	111	198	DZC6	UXC8X6
200 x 200	195	70	160	198	DZC8	UXC8X8

Cable trunking - Fittings and accessories 電線槽曲及配件

Flange 槽吊咀

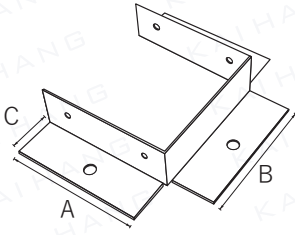

Suitable for trunking size 適用線槽尺寸 (mm)	Dimension 尺寸 (mm)			Model Number 型號
	A	B	C	
50 x 50	48	48	25	CDZ2X2
75 x 50	48	73	25	CDZ3X2
75 x 75	73	73	25	CDZ3X3
100 x 75	73	98	25	CDZ4X3
100 x 100	98	98	25	CDZ4X4
150 x 100	98	148	25	CDZ6X4
150 x 150	148	148	25	CDZ6X6
200 x 150	148	198	25	CDZ8X6
200 x 200	198	198	25	CDZ8X8

Copper earth links 銅水線片

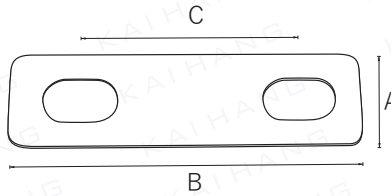

For project type 用於工程種類	Dimension 尺寸 (mm)				Model Number 型號
	Thickness 厚度 mm	A	B	C	
Business Project 一般商用電線槽	0.6	14	48	35	TS75
Architectural Services Department project 建築署用電線槽	1	14	57	35	TS100
Housing Authority Project 房屋署用電線槽	2	12	57	35	TS120
MTRC 地鐵	3	25	58	35	TS150

長度—標準長度3米，其他尺寸可按客戶要求生產
Length—standard length—3m, other lengths available on request
厚度—1.5mm/2.0mm/2.5mm
Thickness—1.5mm/2.0mm/2.5mm

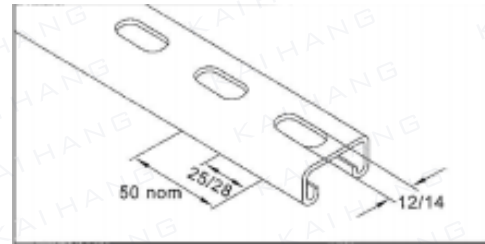
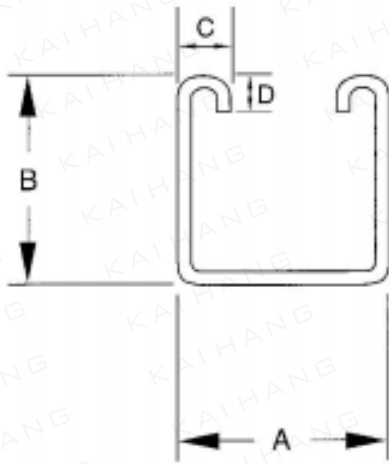
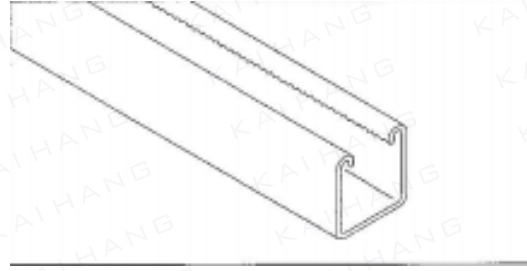
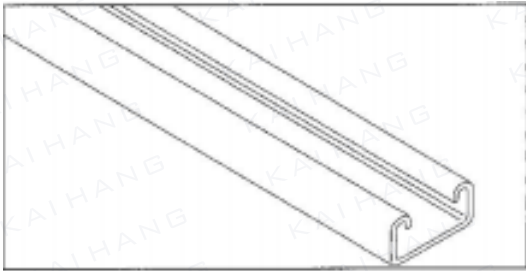

	A	B	C	D	
KHZJ21-15	41	21	10	7	12X25mm , AT 50mm CENTRES
KHZJ41-15	41	41	10	7	12X25mm , AT 50mm CENTRES
KHZJ21-20	41	21	10	7	12X25mm , AT 50mm CENTRES
KHZJ41-20	41	41	10	7	12X25mm , AT 50mm CENTRES
KHZJ21-25	41	21	10	7	12X25mm , AT 50mm CENTRES
KHZJ41-25	41	41	10	7	12X25mm , AT 50mm CENTRES

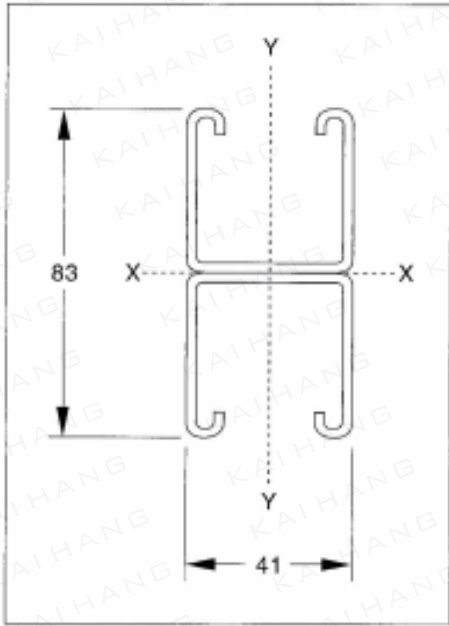

:US 4141

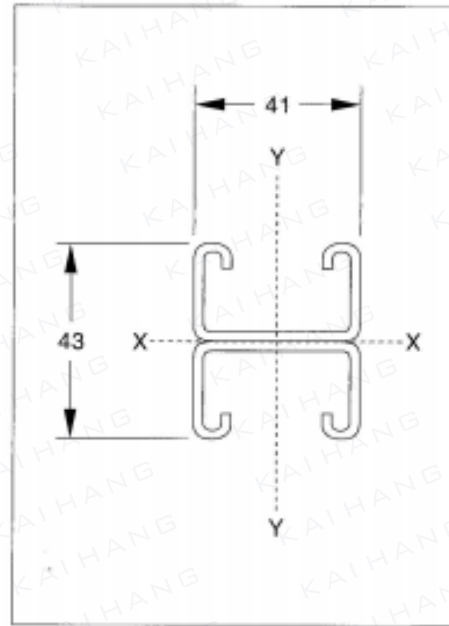

:US 2121

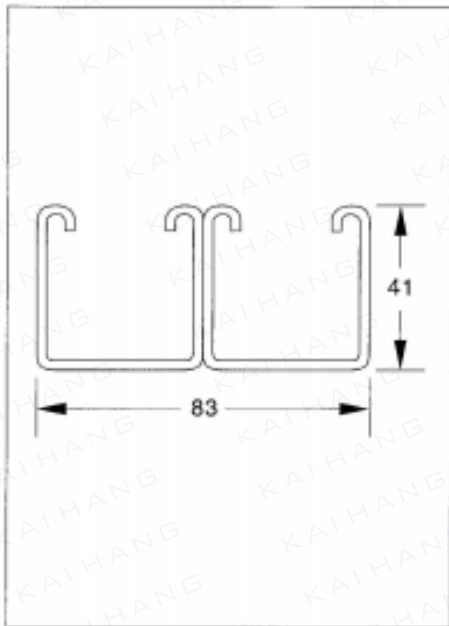

:UP 4141

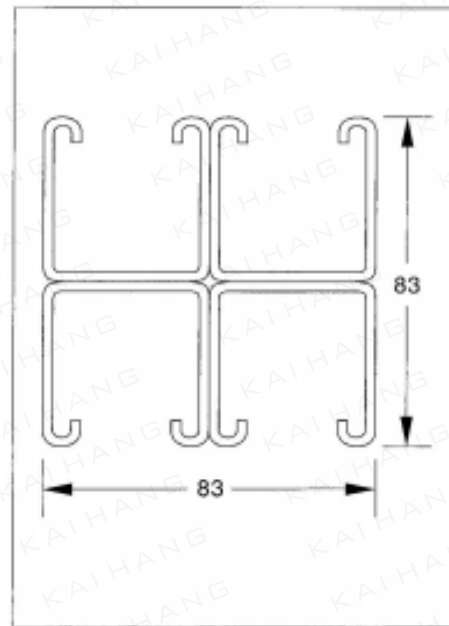

:USP 4141

Cable Tray 電纜托盤

STANDARDS

BS1449, BSEN 10139,
BSEN 10149, IEC61537

規格標準

BS1449, BSEN 10139,
BSEN 10149, IEC61537

FLANGE TYPE

Single Flange (DB)
Return Flange (GB)

摺邊款式

單摺邊 (DB)
雙/勾摺邊 (GB)

FLANGE HEIGHT

Complies with HK government project specifications
Other heights can be produced as needed

邊高

符合香港政府有關部門要求
其他高度可按要求製成

TRAY END STYLE

With / Without built-in
connector

茜身款

茜身連駁款
普通平邊款

MATERIAL

Galvanised Steel Sheet
Mild Steel
Stainless Steel Sheet SS304 (S) /
SS316 (X)

原料

鍍鋅鋼板
鋼板
不銹鋼板SS304 (S),
SS316 (X)

LENGTH

Standard length of 2.44m,
other lengths available on request

長度

標準2.44m,
其他長度可按照客需要

THICKNESS

Complies with HK government project specifications
Other thicknesses can be produced as needed

厚度

符合香港政府有關部門要求
其他厚度可按要求製成

FINISHES

Hot Dip Galvanised to BS729, ISO 1460, 1461
(H)
Coloured Epoxy Powder Coating / High Grade
Outdoor Powder (P)

表面處理

熱浸鋅符合標準BS729, ISO1460, 1461 (H)
顏色聚脂油粉 / 高級戶外粉 (P)

Fittings and accessories meet the same standard and specifications as the trays
配件的規格及標準完全遵照及配合電纜托盤而製成

Cable tray 電纜托盤

Single Flange Type 單摺邊式

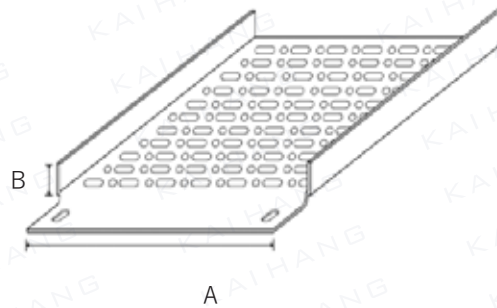

With built-in connector 茜身連駁款

Cable Tray size 電纜托盤 (mm)	Dimension 尺寸 (mm)		Model number 型號			
	A	B	Galvanised Steel 鍍鋅鋼	Hot-dipped Galvanised 熱浸鋅	Stainless Steel SS304 不銹鋼 SS304	Stainless Steel 316 不銹鋼 SS316
50	50	13	DB2AH12	DB2AH12R	DB2AH12S	DB2AH12X
75	75	13	DB3AH12	DB3AH12R	DB3AH12S	DB3AH12X
100	100	13	DB4AH12	DB4AH12R	DB4AH12S	DB4AH12X
150	150	13	DB6AH12	DB6AH12R	DB6AH12S	DB6AH12X
200	200	13	DB8AH15	DB8AH16R	DB8AH15S	DB8AH15X
300	300	20	DB12AH15	DB12AH16R	DB12AH15S	DB12AH15X
400	400	20	DB16AH15	DB16AH16R	DB16AH15S	DB16AH15X
500	500	20	DB20AH20	DB20AH20R	DB20AH15S	DB20AH15X
600	600	20	DB24AH20	DB24AH20R	DB24AH15S	DB24AH15X
700	700	20	DB28AH20	DB28AH20R	DB28AH15S	DB28AH15X
800	800	20	DB32AH20	DB32AH20R	DB32AH15S	DB32AH15X
900	900	20	DB36AH20	DB36AH20R	DB36AH15S	DB36AH15X

Single Flange Type 單摺邊式

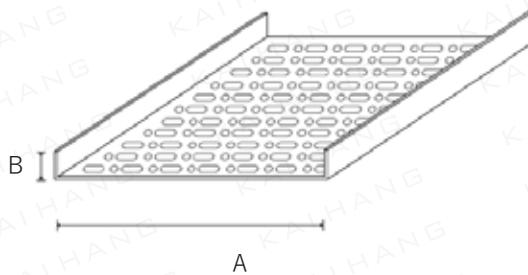

Without built-in connector 普通平邊款

Cable Tray size 電纜托盤 (mm)	Dimension 尺寸 (mm)		Model number 型號			
	A	B	Galvanised Steel 鍍鋅鋼	Hot-dipped Galvanised 熱浸鋅	Stainless Steel SS304 不銹鋼 SS304	Stainless Steel 316 不銹鋼 SS316
50	50	13	DB2BH12	DB2BH12R	DB2BH12S	DB2BH12X
75	75	13	DB3BH12	DB3BH12R	DB3BH12S	DB3BH12X
100	100	13	DB4BH12	DB4BH12R	DB4BH12S	DB4BH12X
150	150	13	DB6BH12	DB6BH12R	DB6BH12S	DB6BH12X
200	200	13	DB8BH15	DB8BH16R	DB8BH15S	DB8BH15X
300	300	20	DB12BH15	DB12BH16R	DB12BH15S	DB12BH15X
400	400	20	DB16BH15	DB16BH16R	DB16BH15S	DB16BH15X
500	500	20	DB20BH20	DB20BH20R	DB20BH15S	DB20BH15X
600	600	20	DB24BH20	DB24BH20R	DB24BH15S	DB24BH15X
700	700	20	DB28BH20	DB28BH20R	DB28BH15S	DB28BH15X
800	800	20	DB32BH20	DB32BH20R	DB32BH15S	DB32BH15X
900	900	20	DB36BH20	DB36BH20R	DB36BH15S	DB36BH15X

Other sizes can be custom made 其他尺寸可按客戶要求生產

Cable tray 電纜托盤

Return Flange Type 勾摺邊式

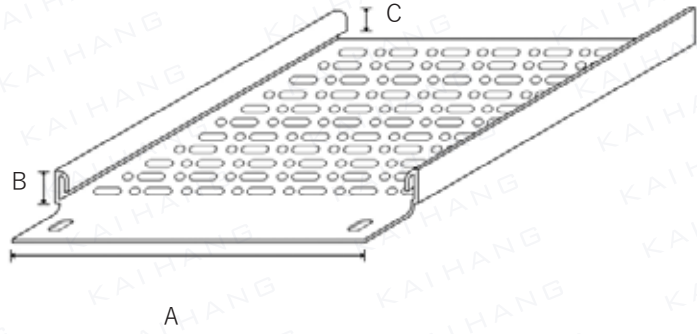

With built-in connector 茜身連駁款

Cable Tray size 電纜托盤 (mm)	Dimension 尺寸 (mm)			Model number 型號			
	A	B	C	Galvanised Steel 鍍鋅鋼	Hot-dipped Galvanised 熱浸鋅	Stainless Steel SS304 不銹鋼 SS304	Stainless Steel 316 不銹鋼 SS316
50	50	20	13	GB2AH12	GB2AH12R	GB2AH12S	GB2AH12X
75	75	20	13	GB3AH12	GB3AH12R	GB3AH12S	GB3AH12X
100	100	20	13	GB4AH12	GB4AH12R	GB4AH12S	GB4AH12X
150	150	20	13	GB6AH12	GB6AH12R	GB6AH12S	GB6AH12X
200	200	20	13	GB8AH15	GB8AH16R	GB8AH15S	GB8AH15X
300	300	20	13	GB12AH15	GB12AH16R	GB12AH15S	GB12AH15X
400	400	20	13	GB16AH15	GB16AH16R	GB16AH15S	GB16AH15X
500	500	20	13	GB20AH20	GB20AH20R	GB20AH15S	GB20AH15X
600	600	20	13	GB24AH20	GB24AH20R	GB24AH15S	GB24AH15X
700	700	20	13	GB28AH20	GB28AH20R	GB28AH15S	GB28AH15X
800	800	20	13	GB32AH20	GB32AH20R	GB32AH15S	GB32AH15X
900	900	20	13	GB36AH20	GB36AH20R	GB36AH15S	GB36AH15X

Return Flange Type 勾摺邊式

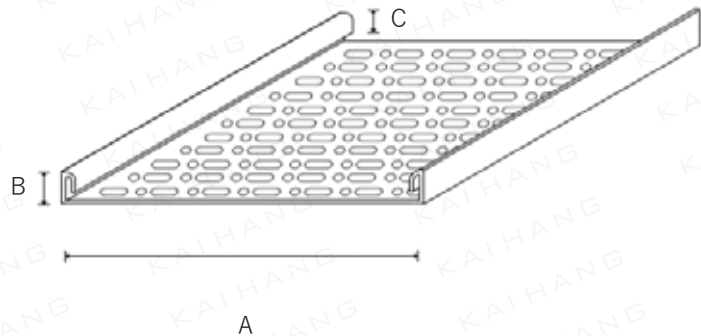

Without built-in connector 普通平邊款

Cable Tray size 電纜托盤 (mm)	Dimension 尺寸 (mm)			Model number 型號			
	A	B	C	Galvanised Steel 鍍鋅鋼	Hot-dipped Galvanised 熱浸鋅	Stainless Steel SS304 不銹鋼 SS304	Stainless Steel 316 不銹鋼 SS316
50	50	20	13	GB2BH12	GB2BH12R	GB2BH12S	GB2BH12X
75	75	20	13	GB3BH12	GB3BH12R	GB3BH12S	GB3BH12X
100	100	20	13	GB4BH12	GB4BH12R	GB4BH12S	GB4BH12X
150	150	20	13	GB6BH12	GB6BH12R	GB6BH12S	GB6BH12X
200	200	20	13	GB8BH15	GB8BH16R	GB8BH15S	GB8BH15X
300	300	20	13	GB12BH15	GB12BH16R	GB12BH15S	GB12BH15X
400	400	20	13	GB16BH15	GB16BH16R	GB16BH15S	GB16BH15X
500	500	20	13	GB20BH20	GB20BH20R	GB20BH15S	GB20BH15X
600	600	20	13	GB24BH20	GB24BH20R	GB24BH15S	GB24BH15X
700	700	20	13	GB28BH20	GB28BH20R	GB28BH15S	GB28BH15X
800	800	20	13	GB32BH20	GB32BH20R	GB32BH15S	GB32BH15X
900	900	20	13	GB36BH20	GB36BH20R	GB36BH15S	GB36BH15X

Other sizes can be custom made 其他尺寸可按客戶要求生產

Cable tray - Fittings and accessories 托盤曲及配件

90° Mitre bend 90° 斜角茜曲

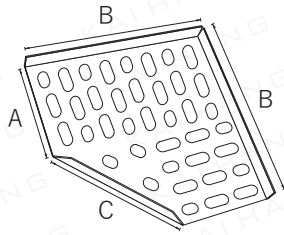

Flat Bend 正曲型

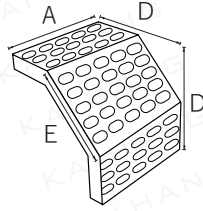

Internal Bend 內曲型

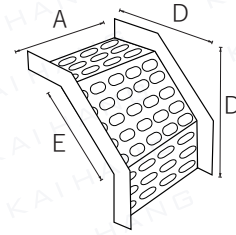

External Bend 外曲型

Suitable for tray size 適用電纜托盤尺寸 (mm)	Dimension 尺寸 (mm)					Model: Single Flange 單摺邊式 (DB), Return Flange 勾摺邊式 (GB)		
	A	B	C	D	E	Flat Bend 正曲型	Internal Bend 內曲型	External Bend 外曲型
50	50	125	106	150	106	DB/GB2.1AH12R	DB/GB2.2AH12R	DB/GB2.4AH12R
75	75	150	106	150	106	DB/GB3.1AH12R	DB/GB3.2AH12R	DB/GB3.4AH12R
100	100	175	106	150	106	DB/GB4.1AH12R	DB/GB4.2AH12R	DB/GB4.4AH12R
150	150	225	106	150	106	DB/GB6.1AH12R	DB/GB6.2AH12R	DB/GB6.4AH12R
200	200	300	141	175	106	DB/GB8.1AH16R	DB/GB8.2AH16R	DB/GB8.4AH16R
300	300	400	141	225	106	DB/GB12.1AH16R	DB/GB12.2AH16R	DB/GB12.4AH16R
400	400	525	177	275	106	DB/GB16.1AH16R	DB/GB16.2AH16R	DB/GB16.4AH16R
500	500	625	177	275	106	DB/GB20.1AH20R	DB/GB20.2AH20R	DB/GB20.4AH20R
600	600	750	212	325	106	DB/GB24.1AH20R	DB/GB24.2AH20R	DB/GB24.4AH20R
700	700	850	212	325	106	DB/GB28.1AH20R	DB/GB28.2AH20R	DB/GB28.4AH20R
800	800	950	212	325	106	DB/GB32.1AH20R	DB/GB32.2AH20R	DB/GB32.4AH20R
900	900	1050	212	325	106	DB/GB36.1AH20R	DB/GB36.2AH20R	DB/GB36.4AH20R

135° Mitre bend 135° 斜角茜曲

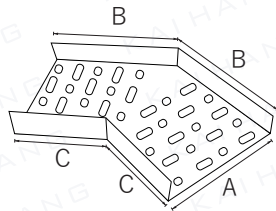

Flat Bend 正曲型

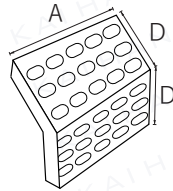

Internal Bend 內曲型

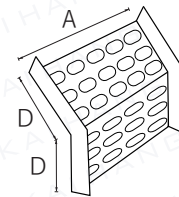

External Bend 外曲型

Suitable for tray size 適用電纜托盤尺寸 (mm)	Dimension 尺寸 (mm)				Model: Single Flange 單摺邊式 (DB), Return Flange 勾摺邊式 (GB)		
	A	B	C	D	Flat Bend 正曲型	Internal Bend 內曲型	External Bend 外曲型
50	50	95	75	75	DB/GB2.11AH12R	DB/GB2.11BH12R	DB/GB2.11CH12R
75	75	106	75	75	DB/GB3.11AH12R	DB/GB3.11BH12R	DB/GB3.11CH12R
100	100	116	75	75	DB/GB4.11AH12R	DB/GB4.11BH12R	DB/GB4.11CH12R
150	150	137	75	75	DB/GB6.11AH12R	DB/GB6.11BH12R	DB/GB6.11CH12R
200	200	158	75	75	DB/GB8.11AH16R	DB/GB8.11BH16R	DB/GB8.11CH16R
300	300	224	100	100	DB/GB12.11AH16R	DB/GB12.11BH16R	DB/GB12.11CH16R
400	400	366	200	200	DB/GB16.11AH16R	DB/GB16.11BH16R	DB/GB16.11CH16R
500	500	407	200	200	DB/GB20.11AH20R	DB/GB20.11BH20R	DB/GB20.11CH20R
600	600	548	300	300	DB/GB24.11AH20R	DB/GB24.11BH20R	DB/GB24.11CH20R
700	700	590	300	300	DB/GB28.11AH20R	DB/GB28.11BH20R	DB/GB28.11CH20R
800	800	631	300	300	DB/GB32.11AH20R	DB/GB32.11BH20R	DB/GB32.11CH20R
900	900	673	300	300	DB/GB36.11AH20R	DB/GB36.11BH20R	DB/GB36.11CH20R

Cable tray - Fittings and accessories 托盤曲及配件

Mitre tee 斜角三叉

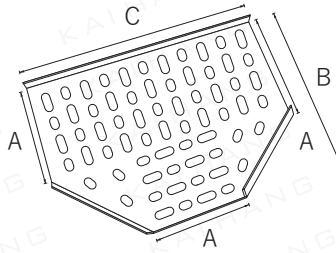

Suitable for tray size 適用電纜托盤尺寸 (mm)	Dimension 尺寸 (mm)			Model: Single Flange 單摺邊式 (DB),
	A	B	C	Return Flange 勾摺邊式 (GB)
50	50	125	200	DB/GB2.3H12R
75	75	150	225	DB/GB3.3H12R
100	100	175	250	DB/GB4.3H12R
150	150	225	300	DB/GB6.3H12R
200	200	300	400	DB/GB8.3H16R
300	300	400	500	DB/GB12.3H16R
400	400	525	650	DB/GB16.3H16R
500	500	625	750	DB/GB20.3H20R
600	600	750	900	DB/GB24.3H20R
700	700	850	1000	DB/GB28.3H20R
800	800	950	1100	DB/GB32.3H20R
900	900	1050	1200	DB/GB36.3H20R

Mitre Cross 十字曲

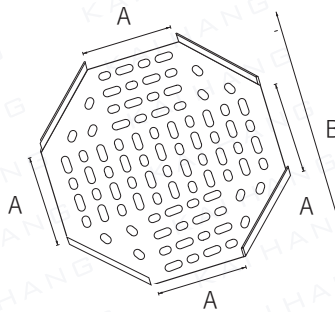

Suitable for tray size 適用電纜托盤尺寸 (mm)	Dimension 尺寸 (mm)		Model: Single Flange 單摺邊式 (DB)
	A	B	Return Flange 勾摺邊式 (GB)
50	50	200	DB/GB2.5H12R
75	75	225	DB/GB3.5H12R
100	100	250	DB/GB4.5H12R
150	150	300	DB/GB6.5H12R
200	200	400	DB/GB8.5H16R
300	300	500	DB/GB12.5H16R
400	400	650	DB/GB16.5H16R
500	500	750	DB/GB20.5H20R
600	600	900	DB/GB24.5H20R
700	700	1000	DB/GB28.5H20R
800	800	1100	DB/GB32.5H20R
900	900	1200	DB/GB36.5H20R

Cable tray - Fittings and accessories 托盤曲及配件

Reducer 刁士

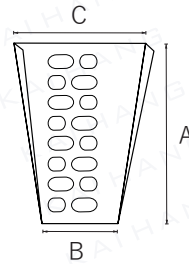

Equal 正刁士

Suitable for tray size 適用電纜托盤尺寸 (mm)	Dimension 尺寸 (mm)			Model: Single Flange 單摺邊式 (DB) Return Flange 勾摺邊式 (GB)
	A	B	C	
75 - 50	150	50	75	DB/GB3.6AH12R
100 - 75	150	75	100	DB/GB4.6AH12R
150 - 100	200	100	150	DB/GB6.6AH12R
150 - 75	200	75	150	DB/GB6.6AH12R
200 - 150	200	150	200	DB/GB8.6AH16R
200 - 100	200	100	200	DB/GB8.6AH16R
300 - 200	300	200	300	DB/GB12.6AH16R
300 - 150	300	150	300	DB/GB12.6AH16R
400 - 300	400	300	400	DB/GB16.6AH16R
600 - 400	500	400	600	DB/GB24.6AH20R

Reducer 刁士

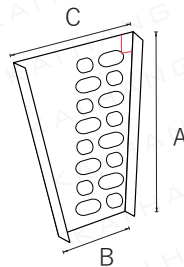

Left 左刁士

Suitable for tray size 適用電纜托盤尺寸 (mm)	Dimension 尺寸 (mm)			Model: Single Flange 單摺邊式 (DB) Return Flange 勾摺邊式 (GB)
	A	B	C	
75 - 50	150	50	75	DB/GB3.6BH12R
100 - 75	150	75	100	DB/GB4.6BH12R
150 - 100	200	100	150	DB/GB6.6BH12R
150 - 75	200	75	150	DB/GB6.6BH12R
200 - 150	200	150	200	DB/GB8.6BH16R
200 - 100	200	100	200	DB/GB8.6BH16R
300 - 200	300	200	300	DB/GB12.6BH16R
300 - 150	300	150	300	DB/GB12.6BH16R
400 - 300	400	300	400	DB/GB16.6BH16R
600 - 400	500	400	600	DB/GB24.6BH20R

Cable tray - Fittings and accessories 托盤曲及配件

Reducer 刁士

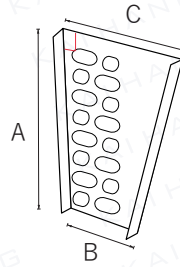

Right 右刁士

Suitable for tray size 適用電纜托盤尺寸 (mm)	Dimension 尺寸 (mm)			Model: Single Flange 單摺邊式 (DB) Return Flange 勾摺邊式 (GB)
	A	B	C	
75 - 50	150	50	75	DB/GB3.6CH12R
100 - 75	150	75	100	DB/GB4.6CH12R
150 - 100	200	100	150	DB/GB6.6CH12R
150 - 75	200	75	150	DB/GB6.6CH12R
200 - 150	200	150	200	DB/GB8.6CH16R
200 - 100	200	100	200	DB/GB8.6CH16R
300 - 200	300	200	300	DB/GB12.6CH16R
300 - 150	300	150	300	DB/GB12.6CH16R
400 - 300	400	300	400	DB/GB16.6CH16R
600 - 400	500	400	600	DB/GB24.6CH20R

Cable tray connector 齒駁片

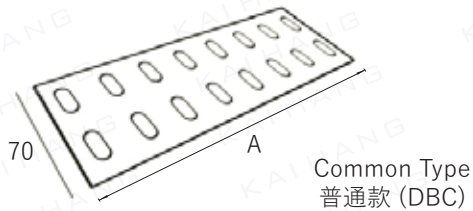

Common Type
普通款 (DBC)

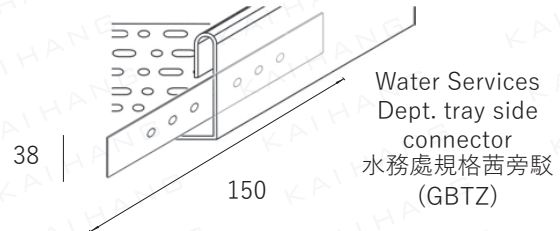

Water Services
Dept. tray side
connector
水務處規格齒旁駁
(GBTZ)

Cable Tray size 電纜托盤 (mm)	Dimension 尺寸 (mm)	Model number 型號			
		Galvanised Steel 鍍鋅鋼	Hot-dipped Galvanised 熱浸鋅	Stainless Steel SS304 不銹鋼 SS304	Stainless Steel 316 不銹鋼 SS316
50	40	DBC2	DBC2R	DBC2S	DBC2X
75	65	DBC3	DBC3R	DBC3S	DBC3X
100	90	DBC4	DBC4R	DBC4S	DBC4X
150	140	DBC6	DBC6R	DBC6S	DBC6X
200	190	DBC8	DBC8R	DBC8S	DBC8X
300	290	DBC12	DBC12R	DBC12S	DBC12X
400	390	DBC16	DBC16R	DBC16S	DBC16X
500	490	DBC20	DBC20R	DBC20S	DBC20X
600	590	DBC24	DBC24R	DBC24S	DBC24X
900	890	DBC36	DBC36R	DBC36S	DBC36X
-	150 x 38	GBTZ	GBTZR	GBTZS	GBTZX